

# VIDEO INTERCOM

## PRODUCTS AND SOLUTIONS

---

2022 Ver. H1



# CONTENT



## VIDEO INTERCOM

### □ PRODUCTS 03-21

- IP Systems
- Analog Apartment Systems
- KIT
- Accessories
- Software & Management Devices
- Emergency Phone Terminals

### □ SOLUTIONS 22-30

- Villa Solution
- Small Apartment Solution
- Big Apartment Solution

# VIDEO INTERCOM







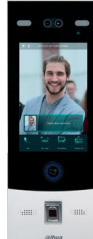
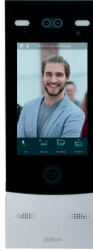

## IP Apartment Door Stations

- 2MP CMOS camera
- OLED, STN, OLED screen
- Night vision
- Echo cancellation
- Voice indicator
- Video & audio messaging

### IP Apartment Door Stations

	Apartment Door Stations		
	VTO9541D	VTO7541G	VTO7521G
Model	 AI	 AI	
Image Sensor	1/2.8" 2MP CMOS	1/2.8" 2MP CMOS	1/2.8" 2MP CMOS
Lens	4mm	4mm	4mm
Angle of View	H: 94.16°, V: 49.57°, D: 113.65°	H: 88°, V: 47°, D: 105°	H: 88°, V: 47°, D: 105°
Day/Night	Color Image	Color Image	Color Image
Screen	10" LCD screen	8" IPS 800x1280	8" IPS 800x1280
Reader	Mifare Card Fingerprint Face Recognition	Mifare Card Fingerprint Face Recognition	Mifare Card
Proximity Sensor	Motion Detection	Motion Detection	Motion Detection
Keypad	Touch Screen	Touch Screen	Touch Screen
Door Control	1 Relay Out 1 RS485 1 Feedback 1 Exit Button	1 Relay Out 1 RS485 1 Feedback 1 Exit Button	1 Relay Out 1 RS485 1 Feedback 1 Exit Button
Ingress Protection	IP65, IK07	IP66, IK07	IP66, IK07
Tamper Switches	1	1	1
Ethernet	10M/100/1000Mbps	10M/100/1000Mbps	10M/100/1000Mbps
Installation	Flush	Surface & Flush	Surface & Flush
Material	Tempered Glass Aluminum	Tempered Glass Aluminum	Tempered Glass Aluminum
Working Temperature	-30°C~+60°C (-22°F~+140°F)	-20°C~+60°C (-4°F~+140°F)	-20°C~+60°C (-4°F~+140°F)
Power Supply	DC12V/2A, Max 18W	DC12V/2A, Max 24W	DC12V/2A, Max 24W

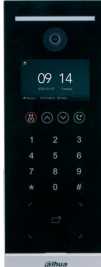
## IP Apartment Door Stations

Apartment Door Stations						
Model	VTO6521F	VTO6521K	VTO6541H	VTO6531H	VTO6521H / VTO6521H-D	VTO6221E-P
						
Image Sensor	1/2.7" 2MP CMOS	1/2.8 2MP CMOS	1/2.7" 2MP CMOS	1/2.7" 2MP CMOS	1/2.7" 2MP CMOS	1/2.9" 2MP CMOS
Lens	2.8mm	4.0mm	4.0mm	4.0mm	2.8mm	2.0mm
Angle of View	H: 113.79°, V: 61.5°, D: 134.45°	H: 86.4°, V: 46.2°, D: 100.6°	H: 87.42°, V: 46.48°, D: 104.13°	H: 87.42°, V: 46.48°, D: 104.13°	H: 113.79°, V: 61.5°, D: 134.45°	H: 138°, V: 78°, D: 158°
Day/Night	Color Image	Color Image	Color Image	Color Image	Color Image	Color Image
Screen	4.3" IPS screen	4.3" LCD	4.3" IPS screen	4.3" IPS screen	4.3" IPS screen	2.3" OLED
Reader	Mifare Card	Mifare Card	Face Recognition Fingerprint Mifare Card	Face Recognition Mifare Card	Mifare Card (VTO6521H) ID Card (VTO6521H-D)	Mifare Card
Proximity Sensor	Motion Detection	Motion Detection	Motion Detection	Motion Detection	Motion Detection	—
Keypad	Mechanical Button with Braille	Mechanical Button	Touchpad	Touchpad	Touchpad	Mechanical Button with Braille
Door Control	1 Relay Out 1 RS485 1 Feedback 1 Exit Button	1 Relay Out 1 RS485 1 Feedback 1 Exit Button	1 Relay Out 1 RS485 1 Feedback 1 Exit Button	1 Relay Out 1 RS485 1 Feedback 1 Exit Button	1 Relay Out 1 RS485 1 Feedback 1 Exit Button	1 Relay Out 1 RS485 1 Feedback 1 Exit Button
Ingress Protection	IP65, IK07	IP65, IK08	IP65	IP65	IP65	IP65, IK08
Tamper Switches	1	1	1	1	1	1
Ethernet	10M/100Mbps	10M/100Mbps	10M/100Mbps	10M/100Mbps	10M/100Mbps	10M/100Mbps
Installation	Surface & Flush	Surface & Flush	Surface & Flush	Surface & Flush	Surface & Flush	Surface & Flush
Material	Aluminum alloy	316 Stainless Steel	PC+ABS	PC+ABS	PC+ABS	Aluminum
Working Temperature	-30°C~+60°C (-22°F~+140°F)	-30°C~+60°C (-22°F~+140°F)	-30°C~+60°C (-22°F~+140°F)	-30°C~+60°C (-22°F~+140°F)	-30°C~+60°C (-22°F~+140°F)	-40°C~+60°C (-40°F~+140°F)
Power Supply	DC12V/2A, Max 18W	DC12V/2A, Max 10W	DC12V/2A, Max 18W	DC12V/2A, Max 18W	DC12V/2A, Max 18W	DC12V/2A, POE(802.3af), Max7W

## IP Modular Door Station

- 2.0MP CMOS camera
- Large field of view
- Night vision
- Voice indicator
- Echo cancellation
- Modular design  
(9 modules max, VTO4202F(FB)-P-S2 needed)

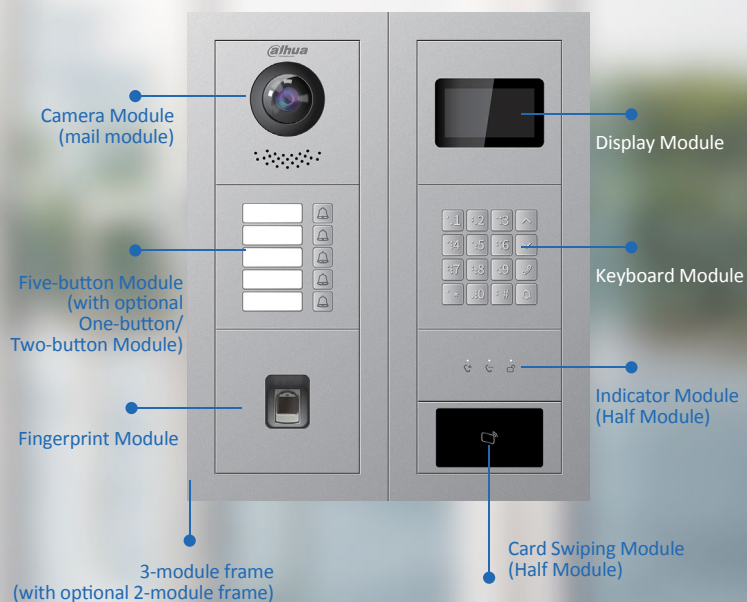





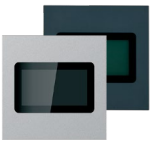

### IP Modular Door Station

#### Modular Door Station Modules

	VTO4202F(FB)-P-S2	VTO4202F(FB)-MB1	VTO4202F(FB)-MB2
Model			
Image Sensor	1/2.5" 2MP CMOS	—	—
Lens	1.9 mm	—	—
Angle of View	H: 168.6°; V: 87.1°; D:176.7°	—	—
Day/Night	ICR	—	—
Screen	—	—	—
Reader	—	—	—
Keypad	—	Mechanical Button	Mechanical Button
Indicator light	—	—	—
Door Control	1 Relay Out 1 RS485 1 Feedback 1 Exit Button	—	—
Ingress Protection	—	IP65, IK07	IP65, IK07
Tamper Switches	1	—	—
Ethernet	10M/100M Network Port	—	—
Installation	Surface & Flush	Surface & Flush	Surface & Flush
Material	Alumimum	Alumimum	Alumimum
Working Temperature	-30°C~+60°C (-22°F~+140°F)	-20°C~+60°C (-4°F~+140°F)	-20°C~+60°C (-4°F~+140°F)
Power Supply	DC12V, PoE(802.3af), Max 12W	DC 5V/1W (Powered by main modules)	DC 5V/1W (Powered by main modules)

# VIDEO INTERCOM







IP Modular Door Station								
	Modular Door Station							
Model	VTO4202F(FB)-MB5	VTO4202F(FB)-MS	VTO4202F(FB)-MF	VTO4202F(FB)-MK	VTO4202F(FB)-ML	VTO4202F(FB)-MR	VTO4202F(FB)-MR1	VTO4202F(FB)-MN
								
Image Sensor	-	-	-	-	-	-	-	-
Lens	-	-	-	-	-	-	-	-
Angle of View	-	-	-	-	-	-	-	-
Day/Night	-	-	-	-	-	-	-	-
Screen	-	3.0" STN	-	-	-	-	-	-
Reader	-	-	Fingerprint	-	-	Mifare Card	ID Card	-
Keypad	Mechanical Button	-	-	Mechanical Button with Braille	-	-	-	-
Indicator light	-	-	-	-	Calling/Answer/Unlock	-	-	-
Door Control	-	-	-	-	-	-	-	-
Ingress Protection	IP65, IK07	IP65, IK07	IP65, IK07	IP65, IK07	IP65, IK07	IP65, IK07	-	IP65, IK07
Tamper Switches	-	-	-	-	-	-	-	-
Ethernet	-	-	-	-	-	-	-	-
Installation	Surface & Flush	Surface & Flush	Surface & Flush	Surface & Flush	Surface & Flush	Surface & Flush	Surface & Flush	Surface & Flush
Material	Alumimum	Alumimum	Alumimum	Alumimum	Alumimum	Alumimum	Aluminum	Alumimum
Working Temperature	-20°C~+60°C (-4°F~+140°F)	-20°C~+60°C (-4°F~+140°F)	-20°C~+60°C (-4°F~+140°F)	-20°C~+60°C (-4°F~+140°F)	-20°C~+60°C (-4°F~+140°F)	-20°C~+60°C (-4°F~+140°F)	-30°C~+60°C (-22°F~+141°F)	-20°C~+60°C (-4°F~+140°F)
Power Supply	DC 5V/1W (Powered by main modules)							

## IP Villa Door Stations





- 1.3/2.0MP CMOS camera
- Night vision
- Voice indicator
- Group calls
- Video & audio messaging
- Remote intercom with mobile app



### IP Villa Door Stations

	Villa Door Stations						
	VTO3221E-P	VTO3311Q-WP	VTO3312Q-P	VTO3211D-P1/P2/P4-S2	VTO2202F-P-S2	VTO2201F-P	VTO2101E-P-S1
Model							
Image Sensor	1/2.9" 2MP CMOS	1/2.8" 2MP CMOS	1/2.8" 2MP CMOS	1/2.8" 2MP CMOS	1/2.5" 2MP CMOS	1/2.9" 2MP CMOS	1/2.7" 2MP CMOS
Lens	2mm	2.2mm	2.2mm	2mm	1.9 mm	2.0 mm	2.8mm
Angle of View	H:138°;V:78°; D:158°	H: 125°; V: 65°; D: 139°	H: 125°; V: 65°; D: 139°	H:129°, V: 74°, D:147°	H: 168.6°; V: 87.1°; D:176.7°	H: 138.6°; V: 79.6°; D:159°	H:77°, V:55°, D:100°
Day/Night	Color Image	Color Image	Color Image	ICR	ICR	ICR	ICR
Indicator light	Calling Answer Unlock	Calling Answer Unlock	Calling Answer Unlock	-	Calling Answer Unlock	Calling Answer Unlock	-
Reader	Mifare Card	Mifare Card	Mifare Card	Mifare Card	-	-	-
Wi-Fi	-	Supported	-	-	-	-	-
Keypad	Mechanical Button with Braille	Mechanical Button	Mechanical Button	Mechanical Button	Mechanical Button	Mechanical Button	Mechanical Button
Door Control	1 Relay Out 1 RS485 1 Feedback 1 Exit Button	1 Relay Out 1 RS485 1 Feedback 1 Exit Button	1 Relay Out 1 RS485 1 Feedback 1 Exit Button	1 Relay Out 1 RS485 1 Feedback 1 Exit Button	1 Relay Out 1 RS485 1 Feedback 1 Exit Button	1 Relay Out 1 RS485 1 Feedback 1 Exit Button	1 Relay out 1 RS485
Ingress Protection	IP65, IK08	IP65, IK08	IP65, IK08	IP65, IK08	IP65, IK07	IP65, IK07	IP65, IK10
Tamper Switches	1	1	1	1	1	1	1
Ethernet	10M/100Mbps	10M/100Mbps	10M/100Mbps	10M/100Mbps	10M/100Mbps	10M/100Mbps	10M/100Mbps
Installation	Surface & Flush	Surface	Surface	Surface	Surface & Flush	Surface & Flush	Surface
Material	Aluminum	Alluminum Alloy	Alluminum Alloy	Aluminum	Aluminum	Aluminum	Front Panel: Zinc alloy Rear Panel: Aluminum alloy Holder: Aluminum alloy
Working Temperature	-40°C~+60°C (-40°F~+140°F)	-40 °C to +60 °C (-40 °F to +140 °F)	-40 °C to +60 °C (-40 °F to +140 °F)	-30°C~+60°C (-22°F~+140°F)	-30°C~+60°C (-22°F~+140°F)	--30°C~+60°C (-22°F~+140°F)	-30°C~+60°C (-22°F~+140°F)
Power Supply	DC12V, PoE(802.3af), Max 7W	DC12 V, PoE (802.3af), Max 6W	DC48 V, Standard PoE, Max 6W;2-Wire	DC12V, PoE(802.3af), Max 7W	DC48V, PoE(802.3af), Max 12W; 2-wire	DC12V, PoE(802.3af), Max 6W	DC 12V,PoE(802.3af), Max 7W





## IP Villa Door Stations

Villa Door Stations					
	VTO2211G-WP	VTO2311R-WP	VTO2211G-P	VTO2301R-P	VTO2111D-P-S2
Model		 <b>NEW</b>		 <b>NEW</b>	
Image Sensor	1/2.8" 2MP CMOS	1/2.8" 2MP CMOS	1/2.8" 2MP CMOS	1/2.8" 2MP CMOS	1/4" 1MP CMOS
Lens	2.1mm	2.2mm	2.1mm	2.2mm	2.1mm
Angle of View	H: 125°,V: 72°,D: 142°	H: 110°; V: 62°; D: 133°	H: 125°,V: 72°,D: 142°	H: 110°; V: 62°; D: 133°	H:107°;V:61°, D:122°
Day/Night	ICR	Color Image	ICR	Color Image	ICR
Indicator light	—	—	Calling Answer Unlock	—	Calling
Reader	Mifare Card	Mifare Card	Mifare Card	—	Mifare Card
Wi-Fi	Supported	Supported	—	—	—
Keypad	Mechanical Button	Mechanical Button	Mechanical Button	Mechanical Button	Mechanical Button
Door Control	1 Relay Out 1 RS485 1 Feedback 1 Exit Button	1 Relay Out 1 RS485 1 Feedback 1 Exit Button	1 Relay Out 1 RS485 1 Feedback 1 Exit Button	1 Relay Out 1 RS485 1 Feedback 1 Exit Button	1 Relay Out 1 RS485 1 Feedback 1 Exit Button
Ingress Protection	IP65	IP65	IP65	IP65	IP65
Tamper Switches	1	1	1	1	1
Ethernet	10M/100Mbps	10M/100Mbps	10M/100Mbps	10M/100Mbps	10M/100Mbps
Installation	Surface	Surface	Surface Mount	Surface	Surface
Material	PC+Acrylic	PC+ABS	PC+Acrylic	PC+ABS	Plastic
Working Temperature	-30°C~+60°C (-22°F~+140°F)	--30°C~+60°C (-22°F~+140°F)	--30°C~+60°C (-22°F~+140°F)	-30°C~+60°C (-22°F~+140°F)	-30°C~+60°C (-22°F~+140°F)
Power Supply	DC 12V/1A, PoE (802.3af), Max 7W	DC12V 1A, PoE (802.3af)	DC 12V/1A,PoE (802.3af), Max 7W	DC12V 1A, PoE (802.3af)	DC12V, PoE (802.3af), Max 5W



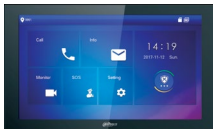
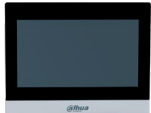

## IP Indoor Monitors



- Color TFT LCD screen
- IPC surveillance
- Alarm integration
- Record and snapshot
- Emergency call
- Excellent design



IP Indoor Monitors					
	Indoor Monitors				
	VTH8641KMS-WP	VTH5341G-W	VTH5441G	VTH8621KMS-WP	VTH5321GB(W)-W
Model	 <sup>NEW</sup>			 <sup>NEW</sup>	
LCD Screen	10" TFT 1024x600 Capacitive	10" TFT 1024x600 Capacitive	10" TFT 1024x600 Capacitive	7" TFT 1024x600 Capacitive	7" TFT 1024x600 Capacitive
System	Linux	Android	Linux	Linux	Android
Button Type	—	—	—	—	—
Wi-Fi	Supported	Supported	—	Supported	Supported
RS485	1	1	—	1	1
Alarm In/Out	6/1	8/1	6/1	6/1	8/1
Memory Slot	Micro SD card (up to 64 GB)	Micro SD, Max 256GB	Embedded 8GB	Micro SD card (up to 64 GB)	Micro SD, Max 256GB
Ethernet	10 /100Mbps Ethernet	10M/100Mbps	10M/100Mbps	10 /100Mbps	10M/100Mbps
Installation	Surface	Surface	Surface	Surface	Surface
Material	Metal	Plastic	Plastic	Metal	PC+ABS
Working Temperature	-10 °C to +55 °C (+14 °F to 131 °F)	-10°C~+55°C (14°F~+131°F)	-10°C~+55°C (14°F~+131°F)	-10 °C to +55 °C (+14 °F to 131 °F)	-10°C~+55°C (14°F~+131°F)
Power Supply	DC 12V, PoE (802.3af), Max 7W	DC12V, PoE (802.3af), Max 7W	DC12V, PoE (802.3af), Max 7W	DC 12V, PoE (802.3af), Max 7W	DC12V, PoE (802.3af), Max 7W

## IP Indoor Monitors

	Indoor Monitors			
	VTH5422HW(B)	VTH5421HW-W	VTH5421HW(B)	VTH5421E(W)-H
Model				
LCD Screen	7" TFT 1024×600 Capacitive	7" TFT 1024×600 Capacitive	7" TFT 1024×600 Capacitive	7" TFT 1024×600 Capacitive
System	Linux	Linux	Linux	Linux
Button Type	—	—	—	—
Wi-Fi	—	Supported	—	—
RS485	1	1	1	1
Alarm In/Out	6/1	6/1	6/1	6/1
Memory Slot	Micro SD card (up to 64 GB)	Micro SD card (up to 64 GB)	Micro SD, 64GB max	Micro SD, 32GB max
Ethernet	10 /100Mbps	10 /100Mbps	10Mbps/100Mbps	10M/100Mbps
Installation	Surface	Surface	Surface	Surface, Desktop
Material	Plastic	Plastic	PC+ABS	Plastic
Working Temperature	-10 °C to +55 °C (+14 °F to 131 °F)	-10 °C to +55 °C (+14 °F to 131 °F)	-10°C to +55°C (+14°F to 131°F)	-10°C~+55°C (14°F~+131°F)
Power Supply	DC 48V 1.25A, PoE (802.3af), Max 6W	DC 12V, PoE (802.3af), Max 6W	12V DC 1A; PoE (802.3af)	DC12V, PoE (802.3af), Max 5W



IP Indoor Monitors			
	Indoor Monitors		
	VTH2421FW-P / VTH2421FB-P	VTH2621G(W)-WP	VTH2621G(W)-P
Model			
LCD Screen	7" TFT 1024x600 Capacitive	7" TFT 1024x600 Capacitive	7" TFT 1024x600 Capacitive
System	Linux	Linux	Linux
Button Type	—	—	—
Wi-Fi	—	Support	—
RS485	—	1	1
Alarm In/Out	6/1	6/1	6/1
Memory Slot	Embedded 8GB	Micro SD card (up to 64 GB)	Micro SD card (up to 64 GB)
Ethernet	10M/100Mbps	10 /100Mbps	10 /100Mbps
Installation	Surface, Desktop	Surface	Surface
Material	Plastic	Plastic	Plastic
Working Temperature	-10°C~+55°C (14°F~+131°F)	-10 °C to +55 °C (+14 °F to 131 °F)	-10 °C to +55 °C (+14 °F to 131 °F)
Power Supply	DC12V, PoE (802.3af), Max 6W	DC 12V 1A, PoE (802.3af), Max 6W	DC 12V 1A, PoE (802.3af), Max 6W





## IP 2-Wire Systems



- 2.0 MP CMOS camera
- Large field of view
- Night vision
- Voice indicator
- Group calls
- Remote intercom with mobile app
- Network signal and power over 2 wires
- Easily replaces existing analog systems

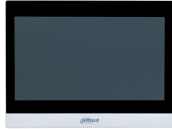

### 2-Wire Villa Door Station

	Villa Door Stations		
	VTO3312Q-P	VTO2202F-P-S2	VTO4202F-P-S2
Model	 <span style="color: red; font-weight: bold;">NEW</span>		 <span style="color: red; font-weight: bold;">NEW</span>
Image Sensor	1/2.8" 2MP CMOS	1/2.5" 2MP CMOS	1/2.5" 2MP CMOS
Lens	2.2mm	1.9 mm	1.9 mm
Angle of View	H: 125°; V: 65°; D: 139°	H: 168.6°; V: 87.1°; D: 176.7°	H: 168.6°; V: 87.1°; D: 176.7°
Day/Night	Color Image	ICR	ICR
Indicator light	Calling Answer Unlock	Calling Answer Unlock	—
Reader	Mifare Card	—	—
Keypad	Mechanical Button	Mechanical Button	—
Door Control	1 Relay Out 1 RS485 1 Feedback 1 Exit Butto	1 Relay Out 1 RS485 1 Feedback 1 Exit Button	1 Relay Out 1 RS485 1 Feedback 1 Exit Button
Ingress Protection	IP65, IK08	IP65, IK07	IP65, IK07
Tamper Switches	1	1	—
2-Wire	Supported	Supported	Supported
Ethernet	10M/100Mbps	10M/100Mbps	10M/100Mbps
Installation	Surface	Surface & Flush	Surface & Flush
Material	Alluminum alloy	Aluminum	Aluminum
Working Temperature	-40 °C to +60 °C (-40 °F to +140 °F)	-30°C~+60°C (-22°F~+140°F)	-30°C~+60°C (-22°F~+140°F)
Power Supply	DC48 V, Standard PoE, Max 6W; 2-Wire	DC12V, PoE (802.3af), Max 12W; 2-wire	DC12V, PoE (802.3af), Max 12W



2-Wire Indoor Monitor		
	Villa Door Stations	
	VTH8642KMS-W	VTH8622KMS-W
Model	 	 
LCD Screen	10" TFT 1024x600 Capacitive	7" TFT 1024x600 Capacitive
System	Linux	Linux
Button Type	—	—
Wi-Fi	Supported	Supported
RS485	1	1
Alarm In/Out	6/1	6/1
Memory Slot	Micro SD card (up to 64 GB)	Micro SD card (up to 64 GB)
Ethernet	10 /100 Mbps Ethernet	10 /100 Mbps Ethernet
Installation	Surface	Surface
Material	Metal	Metal
Working Temperature	-10 °C to +55 °C (+14 °F to 131 °F)	-10 °C to +55 °C (+14 °F to 131 °F)
Power Supply	DC 48V 1.25A, 2-Wire Max 7W	DC 48V 1.25A, 2-Wire Max 7W

2-Wire Indoor Monitor			
	Villa Door Stations		
	VTH5422HW(B)-W	VTH5422HW(B)	VTH2622G(W)-W
Model			
LCD Screen	7" TFT 1024x600 Capacitive	7" TFT 1024x600 Capacitive	7" TFT 1024x600 Capacitive
System	Linux	Linux	Linux
Button Type	—	—	—
Wi-Fi	Supported	—	—
RS485	1	1	1
Alarm In/Out	6/1	6/1	6/1
Memory Slot	Micro SD card (up to 64 GB)	Micro SD card (up to 64 GB)	Micro SD card (up to 64 GB)
Ethernet	10 /100 Mbps Ethernet	10 /100 Mbps Ethernet	10 /100 Mbps Ethernet
Installation	Surface	Surface	Surface
Material	Plastic	Plastic	Plastic
Working Temperature	-10 °C to +55 °C (+14 °F to 131 °F)	-10 °C to +55 °C (+14 °F to 131 °F)	-10 °C to +55 °C (+14 °F to 131 °F)
Power Supply	DC 12V, Standard PoE Max 6W	DC 48V 1.25A, Standard PoE Max 6W	DC 48V 1.25A; 2-Wire Max 6W

## Analog Villa System

- 1.3MP CMOS camera
- Night vision
- Echo cancellation
- Easy installation
- Plug & Play
- Color TFT screen

### Analog Villa System

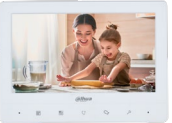
	Villa Door Stations			Villa Indoor Monitors	
	VTO1000J	VTO1000JM		VTH1020J	VTH1020J-T
Model			Model		
Image Sensor	1/4" 1.3MP CMOS	1/4" 1.3 MP CMOS	LCD Screen	7" TFT 1024x600	7" TFT 1024x600
Lens	2.8mm	3.3mm	Button Type	Mechanical Button	Mechanical Button
Angle of View	H:70°, V:40°	H: 70°, V: 40°	Alarm In/Out	—	—
Day/Night	ICR	ICR	Installation	Surface	Surface
Reader	—	—	Snapshot	—	Supported
Keypad	Mechanical Button	Mechanical Button	Material	PC + ABS	PC+ABS
Door Control	1 Relay Out 1 Exit Button	1 Relay Out 1 Exit Button	Working Temperature	-10°C~+55°C (+14°F~+131°F)	-10°C to +55°C (+14°F to +131°F)
Ingress Protection	IP66	IP66, IK07	Power Supply	DC 12V/2A, MAX 5W	DC 12V/2A, MAX 5W
Tamper Switches	—	—			
Installation	Surface	Surface			
Material	PC + ABS	ADC12			
Working Temperature	-30°C~+50°C (-22°F~+122°F)	-30°C to +60°C (-22°F to +140°F)			
Power Supply	DC12V, Max 3W Powered by Indoor Monitor	DC12V, Max 3W Powered by Indoor Monitor			



# VIDEO INTERCOM

## KIT

- New package style, new experience
- Multiple combinations to meet diverse requirements
- Complete accessories, easy installation and operation
- Quick configuration
- Cost-effective



IP



KTP01L

IP



KTP02

IP



KTP03

IP



KTP04

Analog



KTA02

Analog



KTA02M

Analog



KTA03

Analog



KTA03M

# VIDEO INTERCOM

## KIT

- New package style, new experience
- Multiple combinations to meet diverse requirements
- Complete accessories, easy installation and operation
- Cost-effective



WiFi



KTW01

WiFi

NEW



KTW02

2-wire



KTD01L

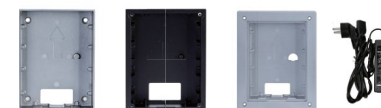
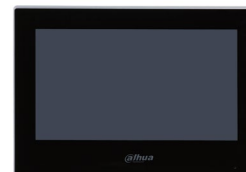

2-wire

NEW





KTD02

# ACCESSORIES

VTO6521K		
		
Model	VTOB103	VTM57R
Installation	Flush	Surface

VTO75x1G / VTO65x1H / VTO6521F		
		
Model		VTM121
Installation		Flush
		VTM130
		Surface





VTO3311Q-WP / VTO3312Q-P		
		
Model		VTM58
Installation	Multicolor casings	
	VTM57	



VTO1000J / VTO1000J-T		
		
Model	VTM22A	VTM23A
Type	Horizontally inclined bracket	Vertically inclined bracket

VTO2202F-P / VTO2202F-P-S2		
		
Model	VTM114	VTM115
Installation	Flush	Surface

VTO4202F(FB) Series		
		
Model	VTM125 / VTM25P2	VTM126 / VTM24P3
Description	For 2-module VTO4202F/FB	For 3-module VTO4202F/FB

Rain Cover									
									
Model	VTM51R2 / VTM30R2	VTM52R2 / VTM26R2	VTM53R3 / VTM27R3	VTM54R4 / VTM28R4	VTM56R6 / VTM29R6	VTM05R	VTM07R	VTM08R	VTM09R
Description		For VTO4202F-X / VTO4202FB-X series				For VTO2202F / VTO2201F series	For VTO3211D-P1/P2/P4 series	For VTO3221E / VTO6221E series	For VTO2211G series

	2-Wire		Access Control	Lift Controller	Call Lift Module
Model	VTNS2003B-2		DEE1010B	VTM416	VTM401
Appearance					
Description	10-level cascade through the 2-wire device port; Supports connection with 20 indoor monitors and 2 door stations; Supports connection through RJ45 port		RS485 convertor DC12V, Max 1W	Supports 8 cascading, up to 128 floors permission control DC 12V/2A	Call lift to the designated floor through the indoor monitor DC 12V/1A

	Power Supplies		Distributed Power Supply	UPS
Model	PFM321D Series		PFA34x Series	PFM35x Series
Appearance				
Description	DC12V, 1A		DC12V, 4A-5CH/5A-9CH/10A-9CH/20A-19CH	Line-interactive: 600VA/360W, 1500VA/900W Smart-online: 1000VA/900W

# SOFTWARE & MANAGEMENT DEVICES

## DMSS

### Digital Mobile Surveillance System

Answer the door with your smartphone  
Unlock remotely

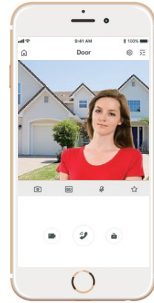

Devices	Add Device Method	IP/domain, SN
	Supported Devices	Villa VTO, Modular VTO, IPC
VDP Operation	Talk	Video talk with VTO
	Control	Open door remotely
	Alarm Push	Local Alarm
Live Preview	Features	Snapshot, Record
Minimum System Requirements	OS	Android 5.0 or above; iDMSS: IOS 9.0 or above
	CPU	1GHz or above
	RAM	1G or above
	Display Resolution	480x800 or above

## DSS Agile VDP

Monitor VTO via mobile phone  
Receive the call transferred from VTH  
Unlock the VTO remotely  
Send unlock notification to mobile phone  
Supports maximum of 5,000 users, with up to 5 users per household



Devices	Add Device Method	IP/Domain
	Supported Devices	SIP VDP devices
VDP Operation	Talk	Receive video calls transferred from VTH
	Control	Open door remotely
	Alarm Push	Supported
Live View	Features	Unlock history, call history
Minimum System Requirements	OS	Android: 4.0 or above; iOS: 9.0 or above
	CPU	1 GHz or above
	Memory	Android: 2GB or above; iOS: 1GB or above
	Display Resolution	480x800 or above

## VTS5340B

### Master Station

- Receive calls from devices
- Monitor door station
- Unlock remotely



Max. Management VTOs	50
LCD Screen	10" TFT 1024x600 Capacitive
Button Type	Touch
Audio In/Out	4/1
Ethernet	100M/1000Mbps
Material	PC + ABS
Working Temperature	-10°C~+55°C (+14°F~+131°F)
Power Supply	DC 12V/2A, MAX 24W

## Video Intercom SIP Server

- Receive emergency calls from devices
- Monitor door stations
- Send public messages
- Unlock remotely
- Card/Fingerprint Management



Devices & Users	Max. Linked VDPs	SIP ID<256 DSS Express SIP ID<1000 DSS Pro SIP ID<1000 DSS4004-S2 SIP ID<2000 DSS7016-S2
VDP Operation	Talk	2-way video talk between VTO and control center 2-way audio talk between VTH/SIP phone and control center VTH and SIP phone group call Push notification to VTH Transfers video talk request to mobile phone from VTH Supports maximum of 50 simultaneous calls
	Control	Control center and mobile phone remote unlock SIP phone remote unlock by the password All-in-one access control management (face, card, fingerprints)
	Announcement	Send text message to VTH
Live View	Video Display Split	1/4/6/8/9/16/25/36 or customized split for Mac; Up to 64-bit for Windows
	Max. Preview Screen	4
	Features	Snapshot, Audio, Record, Talk, Playback, etc.
Minimum System Requirements	OS	OS for Server: Windows 7/Windows 8.1/Windows 10/Windows Server 2008 OS for Control Client: Windows 7/Windows 8.1/Windows 10
	Disk Space	200GB or higher for DSS Express
	Memory	8GB
	Display Resolution	1024x768 or above

# > IP Villa Solution (1-Flat)

Our IP Villa Solution offers a rich set of features such as remote intercom, door control, real-time video surveillance, and push notifications for mobile phones. No matter where you are, no visitors or messages will be missed.

20 + Doors + 10 Monitors

CAT5e: Devices to Switch, max 100m  
 Relay  
 Wi-Fi

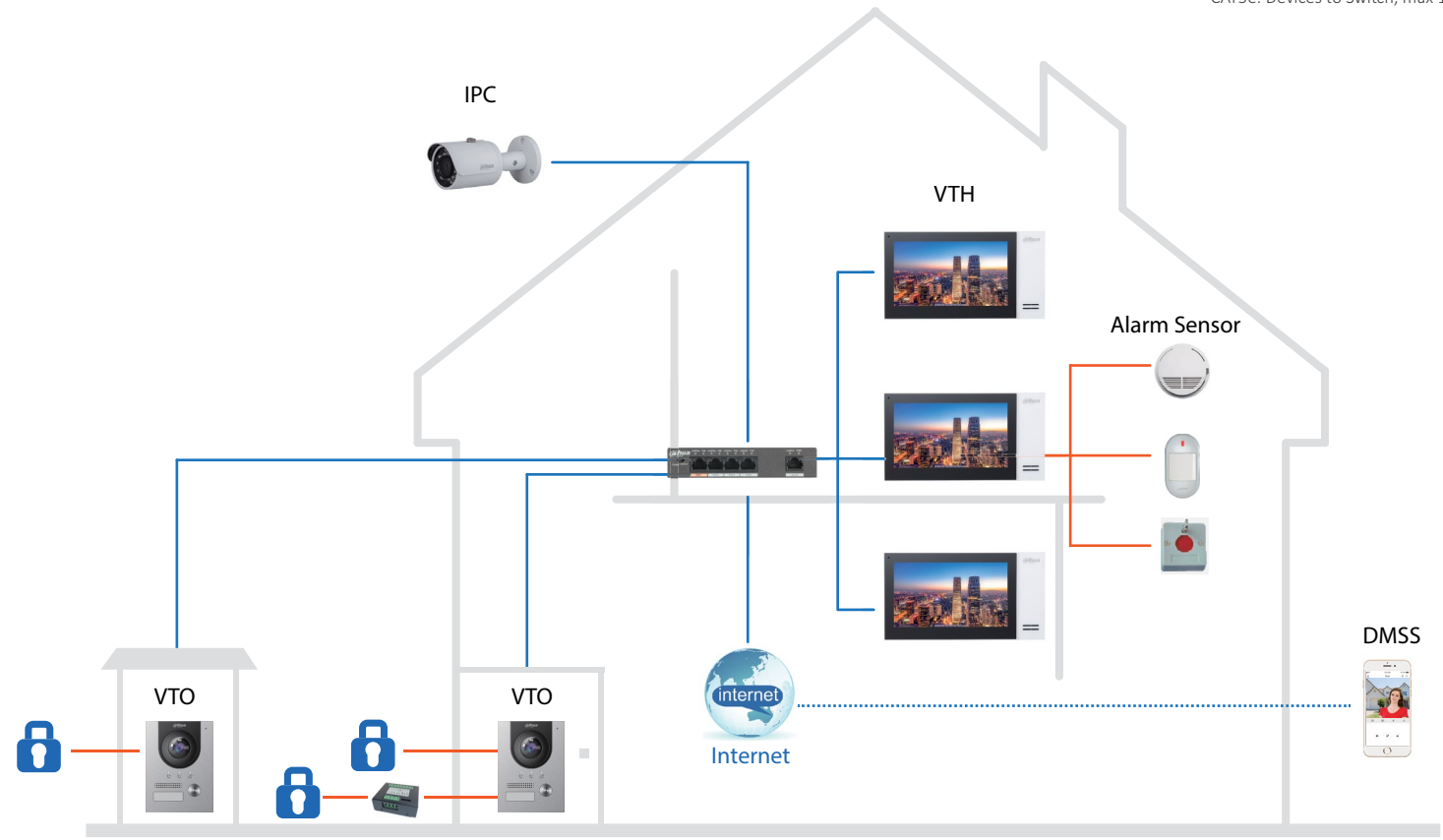

## Features



Video & Audio Calls



Night Vision



Group Calls



Emergency Calls



Standard PoE



Remote Unlock



Alarm Integration



Video & Audio Messaging



IPC Surveillance

## Recommended Products



**VTO2201F-P**

Villa Door Station  
 2MP CMOS, 140°  
 IP65, IK07



**VTH2421FW-P**

IP Indoor Monitor  
 7" Capacitive

2 Doors + 20 Monitors  
(6 devices max)

— CAT5e: Devices to Switch, max 100m  
— 2-Wire: VTH to Switch, max 100m

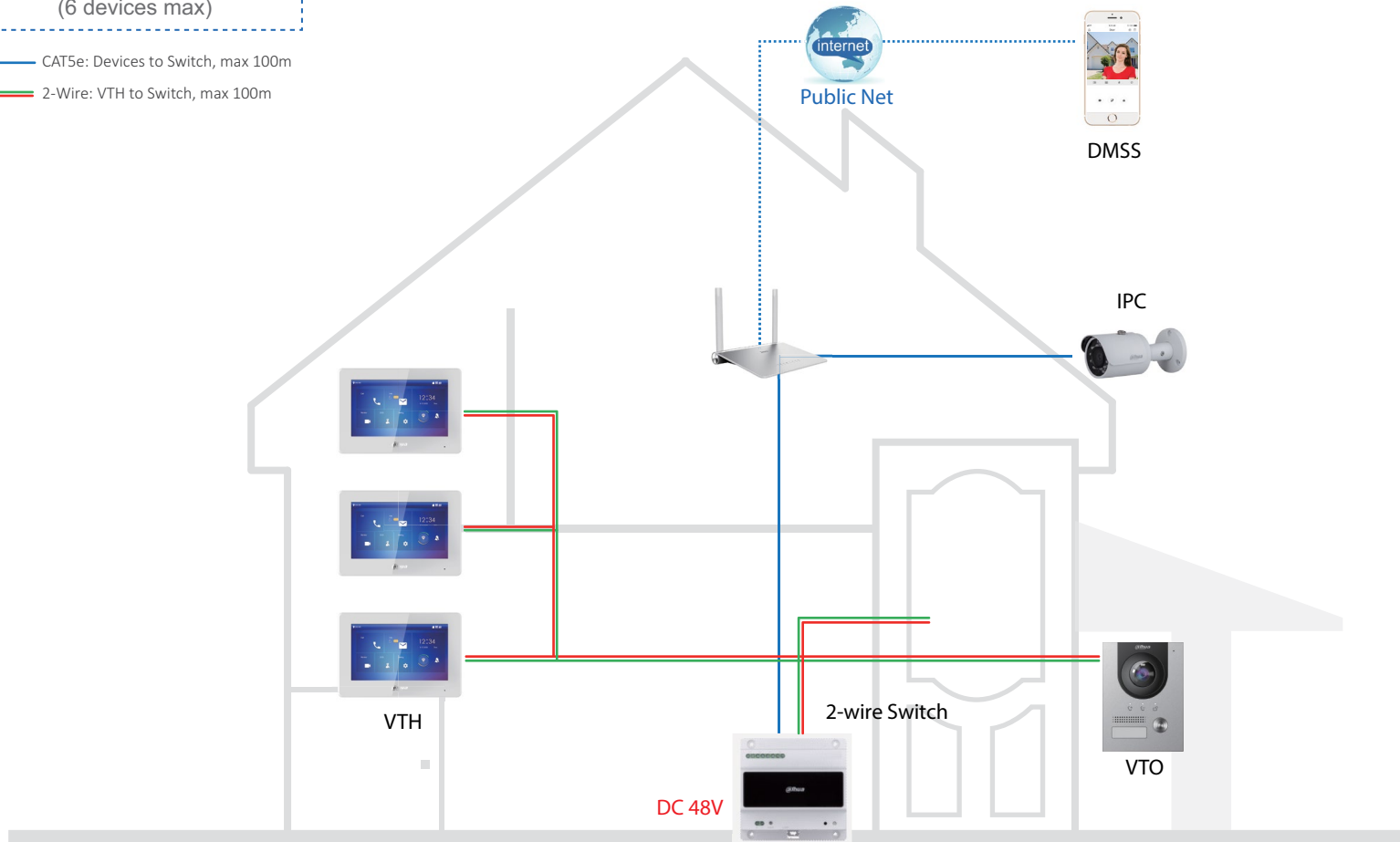

## IP 2-Wire Villa Solution

This system uses two wires to transmit data signals and power. The 2-wire indoor monitors access the Internet easily through a special converter. The system can easily adapt to multiple wiring environments and can enable all digital villa functions. Replace your existing analog villa system with the Dahua Villa Solution and create a complete IP world.

### Features



Video & Audio Calls



Night Vision



Group Calls



Smartphone App



Remote Unlock



Alarm Integration



Video & Audio Messaging



IPC Surveillance

### Recommended Products



#### VTO2202F-P-S2

Villa Door Station  
2MP CMOS, 160°  
IP65, IK07



#### VTH5422HW

Indoor Monitor  
7" Capacitive  
2.5D glass screen

# Wi-Fi Villa Solution

The Wi-Fi Villa Solution integrates video intercom, remote control, real-time video surveillance, and intrusion detection into an all-in-one platform. Door stations, indoor monitors, alarm detectors, and smart lock work together through Wi-Fi and Dahua Airfly to create a wireless smart home system. Wi-Fi door stations can function as a doorbell and can be remotely controlled with a smartphone.

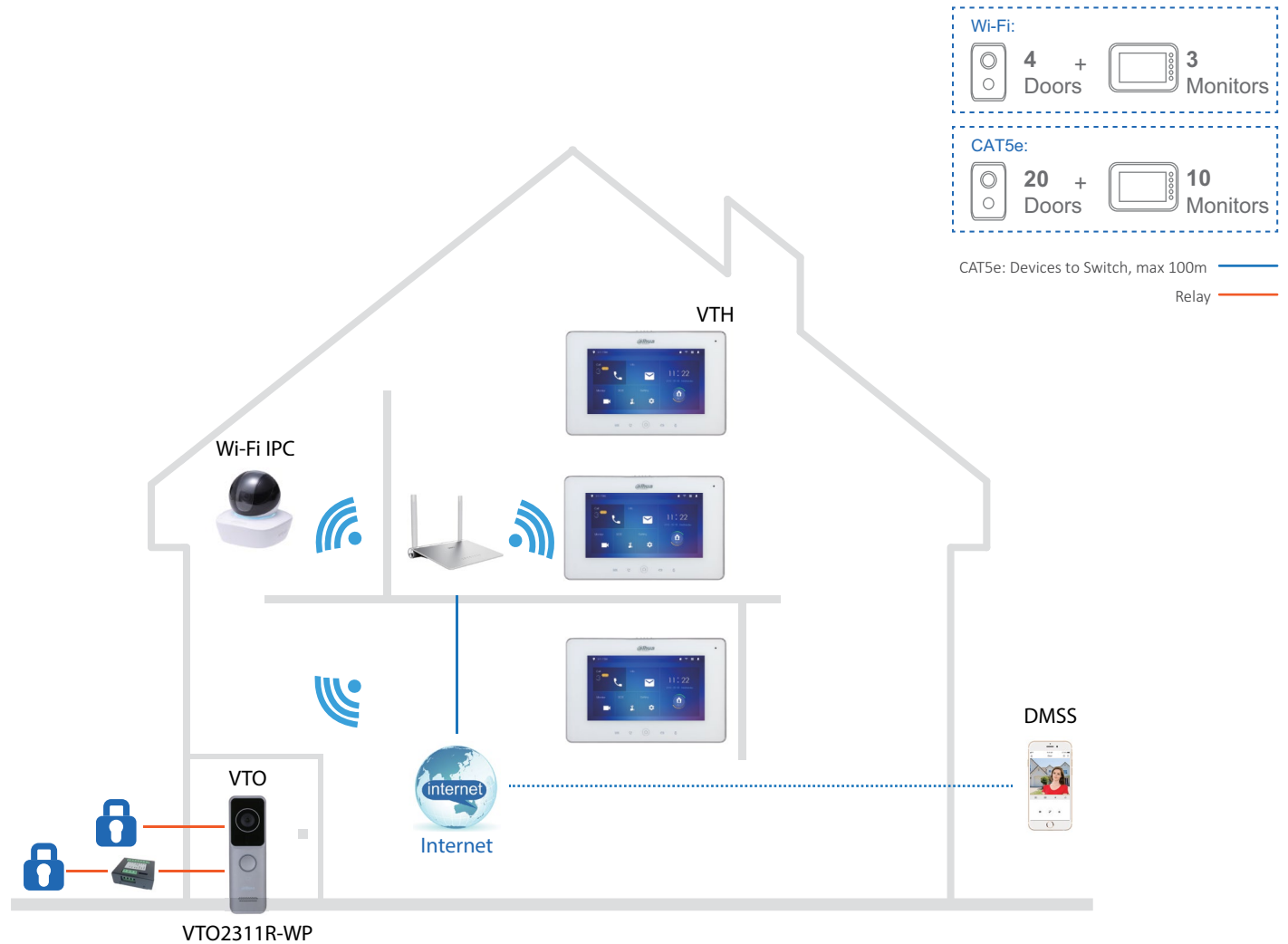

## Features



Video & Audio Calls



Night Vision



Group Calls



Emergency Calls



Wi-Fi



Remote Unlock



Alarm Integration



Video & Audio Messaging



IPC Surveillance



Standard PoE

## Recommended Products



**VTO2311R-WP**

Wi-Fi Villa Door Station  
2MP CMOS  
IP65



**VTH5221D-S2**

Wi-Fi Indoor Monitor  
7" Capacitive, 1024x600

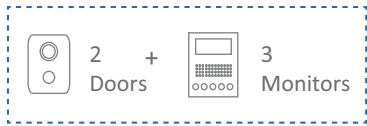

 RVV4: Devices to devices, max 50m

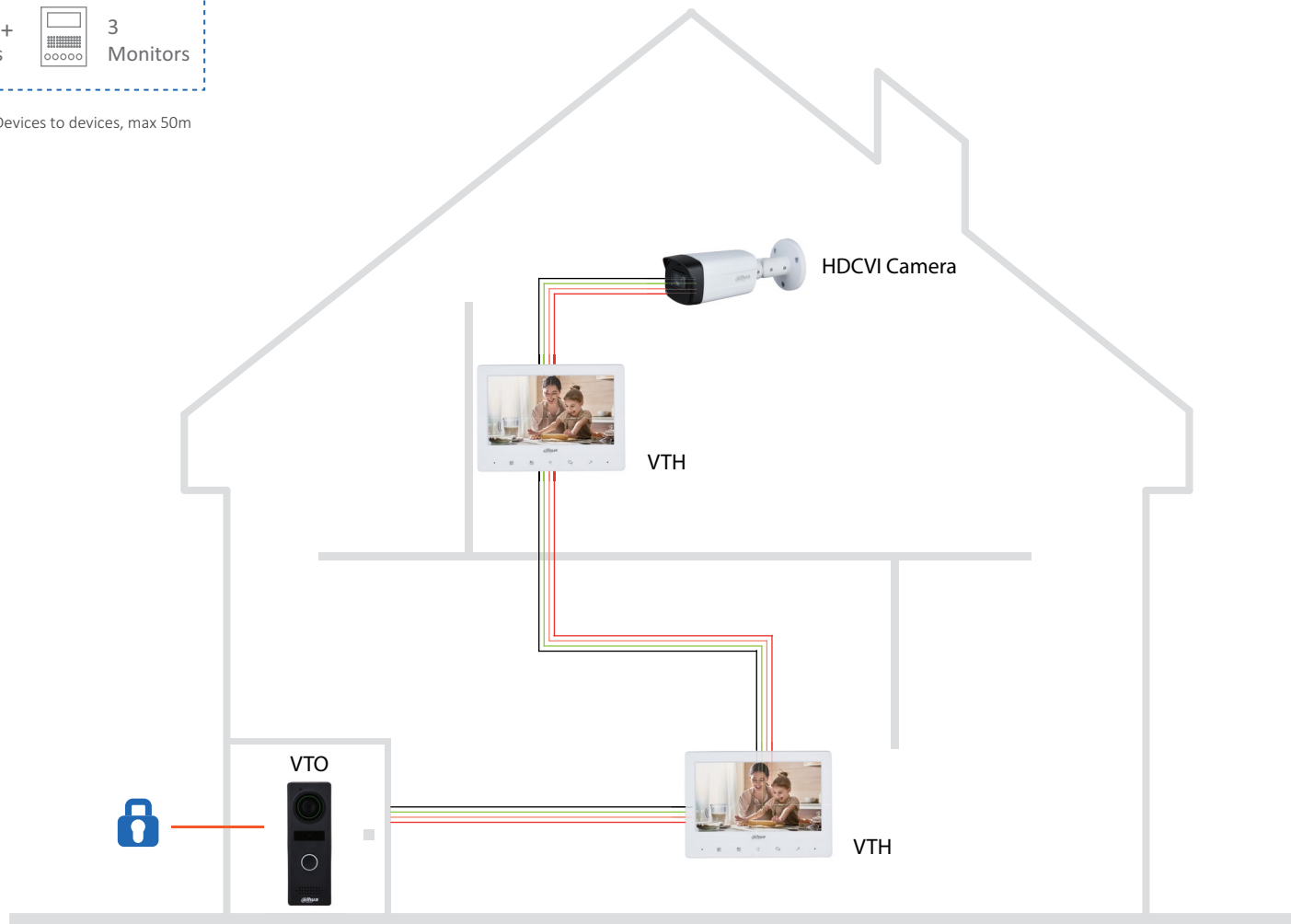

## > Analog Villa Solution

The Analog Villa Solution provides an easy-to-install plug & play system that delivers high video quality and nearly zero video delay.

### Features



Video & Audio Calls



Night Vision



Group Calls



Alarm Integration

### Recommended Products



#### VTO1000JM

Villa Door Station  
1.3MP Camera  
IP66, IK07

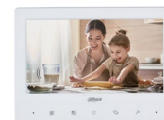

#### VTH1020J

Indoor Monitor  
7" TFT Screen

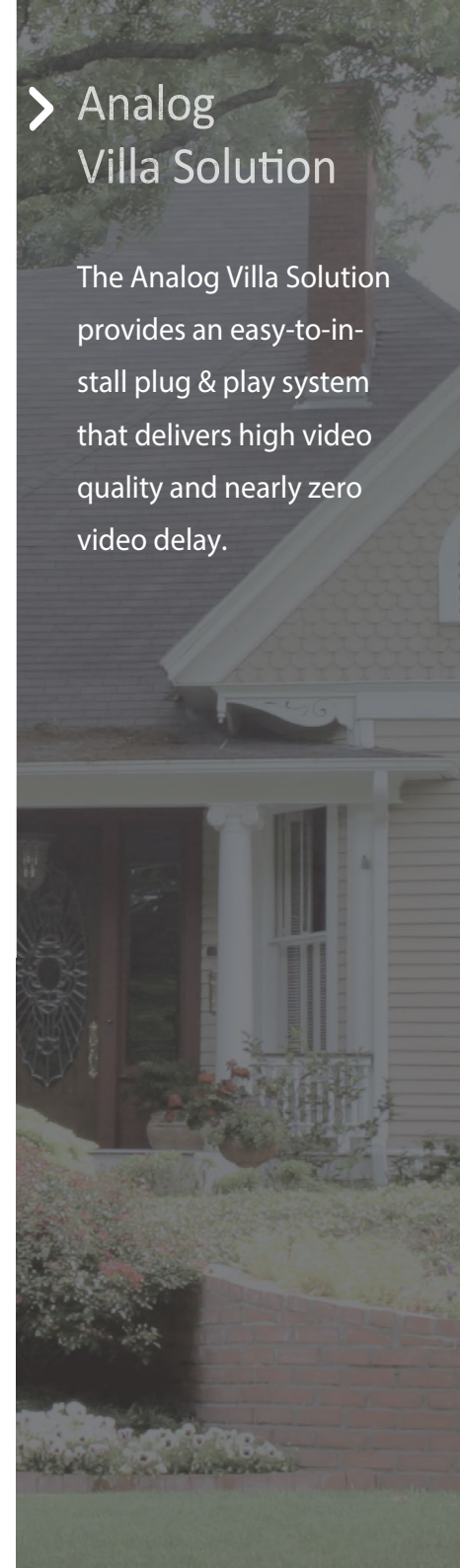

# › IP Villa Solution (1/2/4-Flat)

Our IP Villa Solution comes complete with a rich set of features such as remote intercom, door control, real-time video surveillance, and notifications pushed to your mobile phone. No matter where you are, no visitors or messages will be missed.

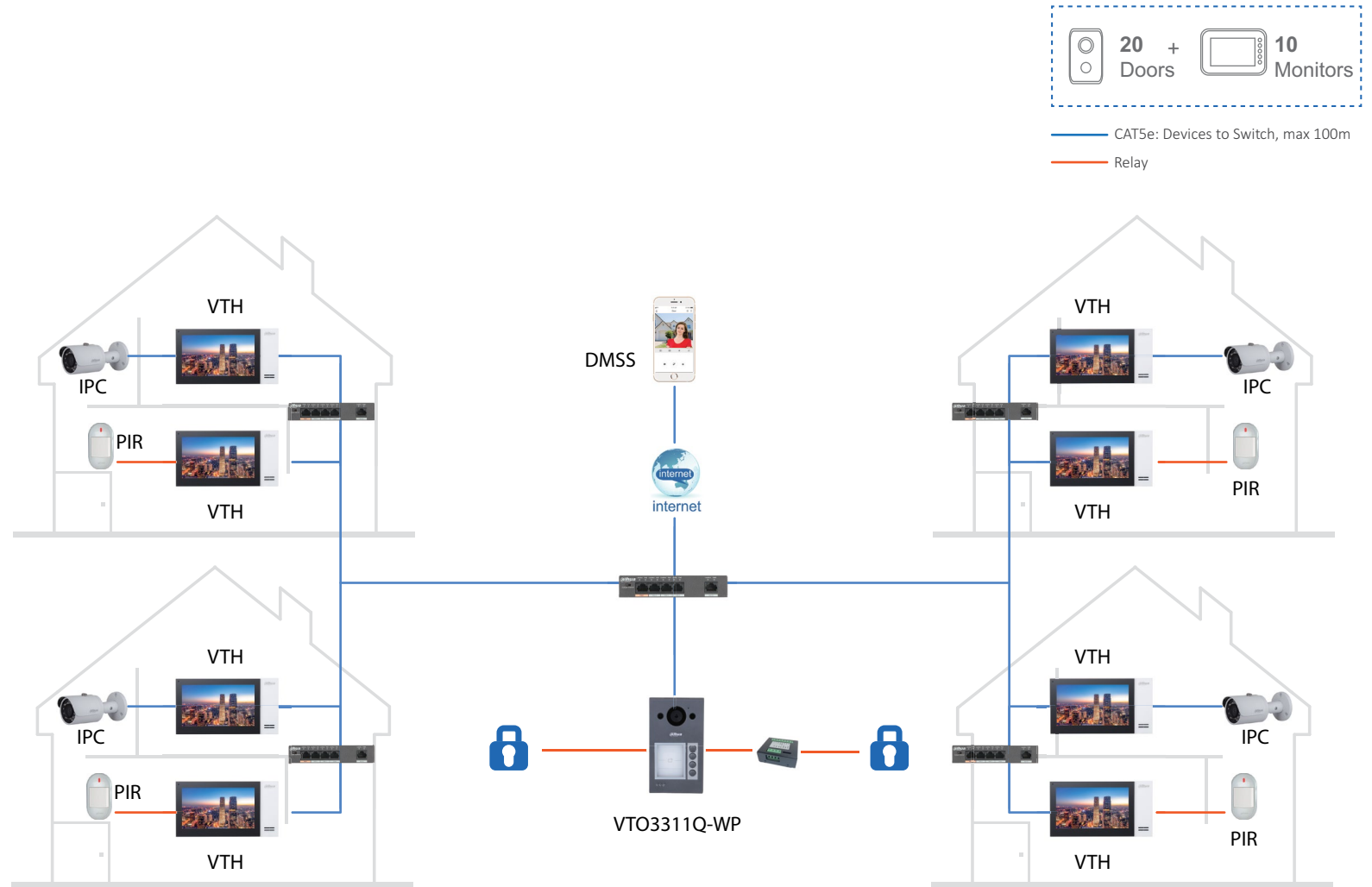

## Features



Video & Audio Calls



Night Vision



Group Calls



Emergency Calls



Remote Unlock



Alarm Integration



Video & Audio Messaging



IPC Surveillance



Mobile Application



Standard PoE

## Recommended Products



### VTO3311Q-WP

Villa Door Station  
2MP CMOS  
IP65, IK08



### VTH2421FW-P

Wi-Fi Indoor Monitor  
7" Capacitive,  
1024x600

10 + Doors + 200 (40 flats) Monitors  
(Per building)

— CAT5e: Devices to Switch, max 100m  
Switch to Switch, max 30m  
— Relay

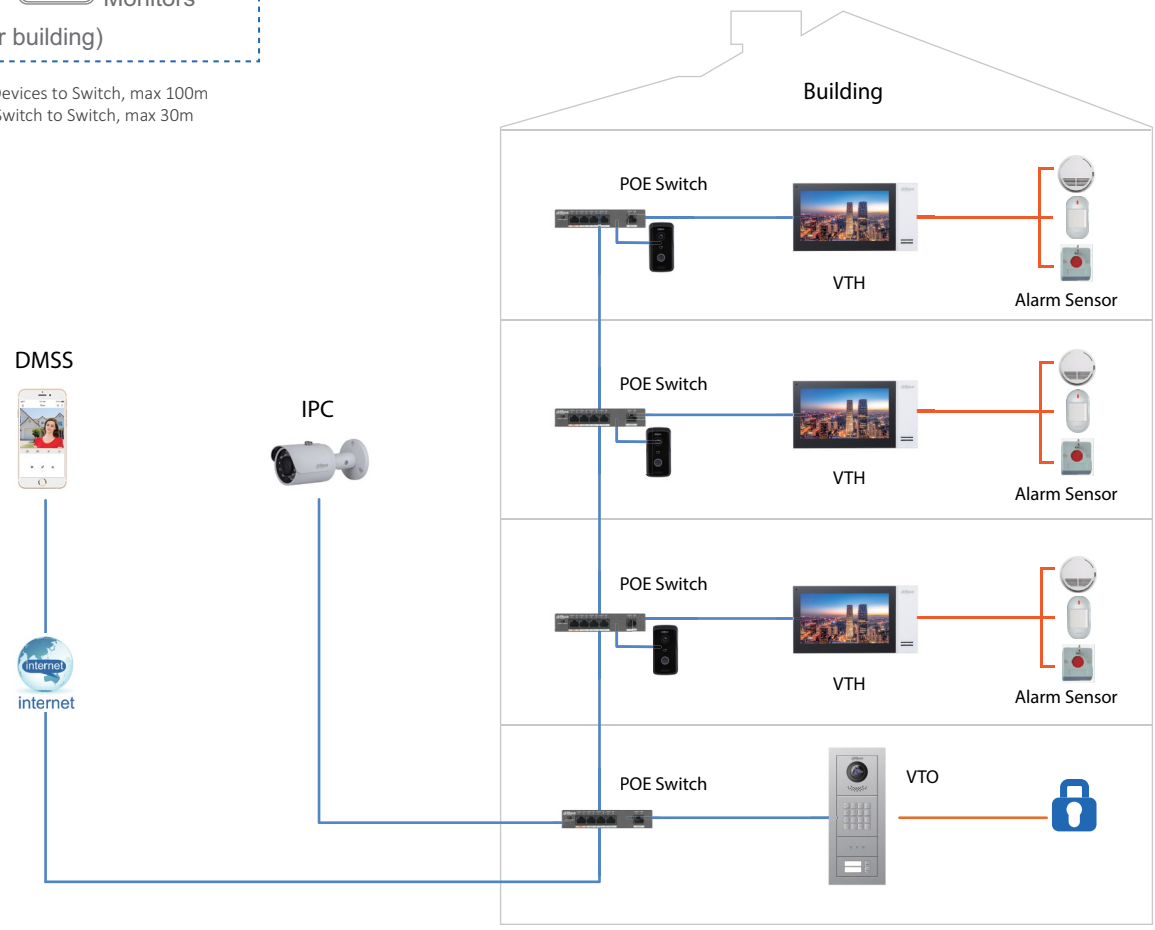

## > IP Small Apartment Solution

The flexible modular design with camera, button, keyboard, reader, and fingerprint modules allows you to choose which components to use and install on 2-module, 3-module, or 9-module front panels. One-button calling enables convenient communication between visitors and residents in small apartment applications.

### Features

### Recommended Products

- Video & Audio Call
- Night Vision
- Group Calls
- Emergency Calls
- Modular Design
- Remote Unlock
- Alarm Integration
- Video & Audio Messaging
- IPC Surveillance
- Mobile Application

		<b>VTO4202F-P</b> Camera module 2MP 160° IP65, IK07	<b>VTO4202F-MB5</b> Five-button module IP65, IK07	
		<b>VTO4202F-MS</b> Display module 3.0" STN IP65, IK07	<b>VTO4202F-MF</b> Fingerprint module IP65, IK07	<b>VTH2421FW-P</b> IP Indoor Monitor 7" Capacitive, 1024x600

# > IP 2-wire Small Apartment Solution

The IP 2-Wire Apartment Solution uses two wires to transmit data signals and power. Flexible modular design with camera, button, keyboard, reader, and fingerprint modules allows you to choose which components to use and install on 2-module, 3-module, or 9-module front panels.

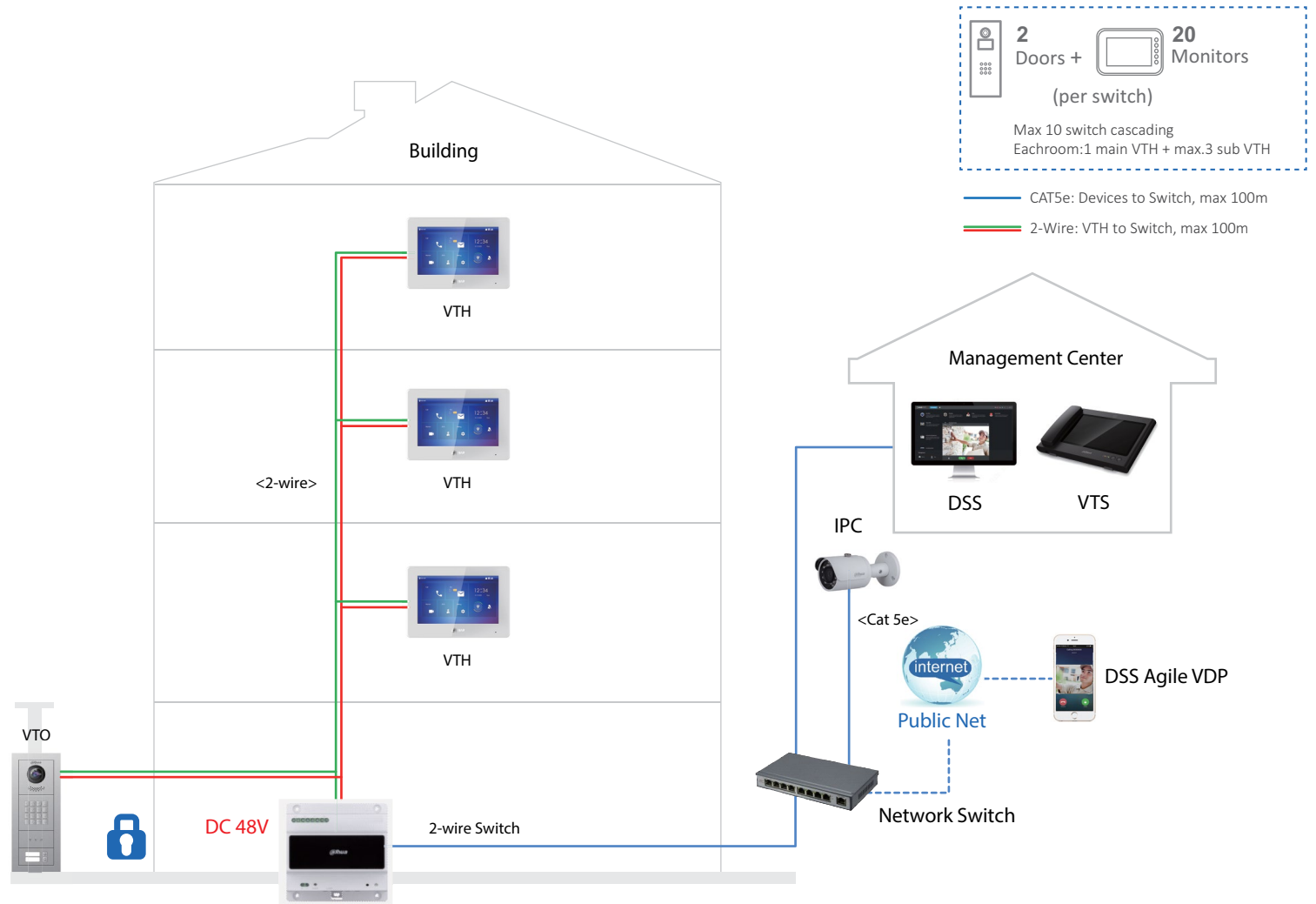

## Features



Video & Audio Call



Night Vision



Group Calls



Emergency Calls



Modular Design



Remote Unlock



Alarm Integration



Video & Audio Messaging



IPC Surveillance



Mobile Application

## Recommended Products



**VTO4202F-P-S2**  
Camera module  
2MP 160°  
IP65, IK07



**VTO4202F-MB5**  
Five-button module  
IP65, IK07

**VTO4202F-MS**  
Display module  
3.0" STN  
IP65, IK07

**VTO4202F-MF**  
Fingerprint module  
IP65, IK07



**VTH5422HW**  
Indoor Monitor  
7" Capacitive  
2.5D glass screen

# > IP Apartment Solution

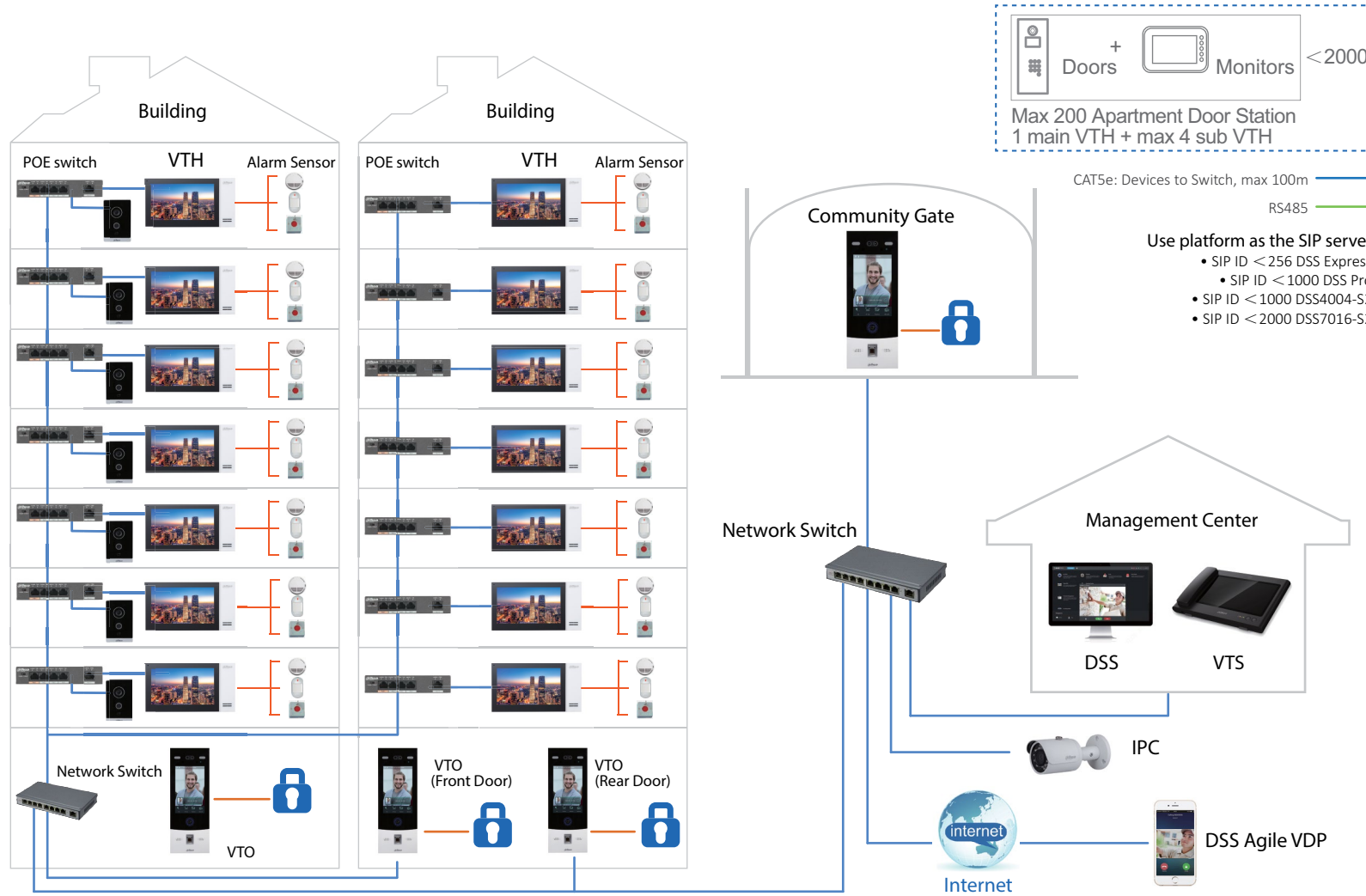

The IP Apartment Solution provides a large scale system with rich functionality such as video intercom, real-time video surveillance and intrusion detection. Various authentication methods (password, RFID card) provide maximum security. Management center calling capabilities as well as calling between residents provide great convenience to residents and property management personnel.

## Features



Video & Audio Calls



Night Vision



Group Calls



Emergency Calls



Remote Unlock



Alarm Integration



Video & Audio Messaging



IPC Surveillance



Mobile Application

## Recommended Products

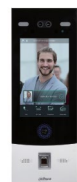

**VTO7541G**

Unit Door Station  
2MP COMS  
Face & Fingerprint  
IP66, IK07



**VTH2421FW-P**

IP Indoor Monitor  
7" Capacitive, 1024x600

# > IP 2-Wire Apartment Solution

The IP 2-Wire Apartment Solution uses two wires to transmit data signals and power. The 2-wire indoor monitors can access the Internet easily through a special converter. The system can easily adapt to multiple wiring environments and can enable all digital apartment functions. Replace your existing analog apartment system with the Dahua IP 2-Wire Apartment Solution and create a complete IP world.

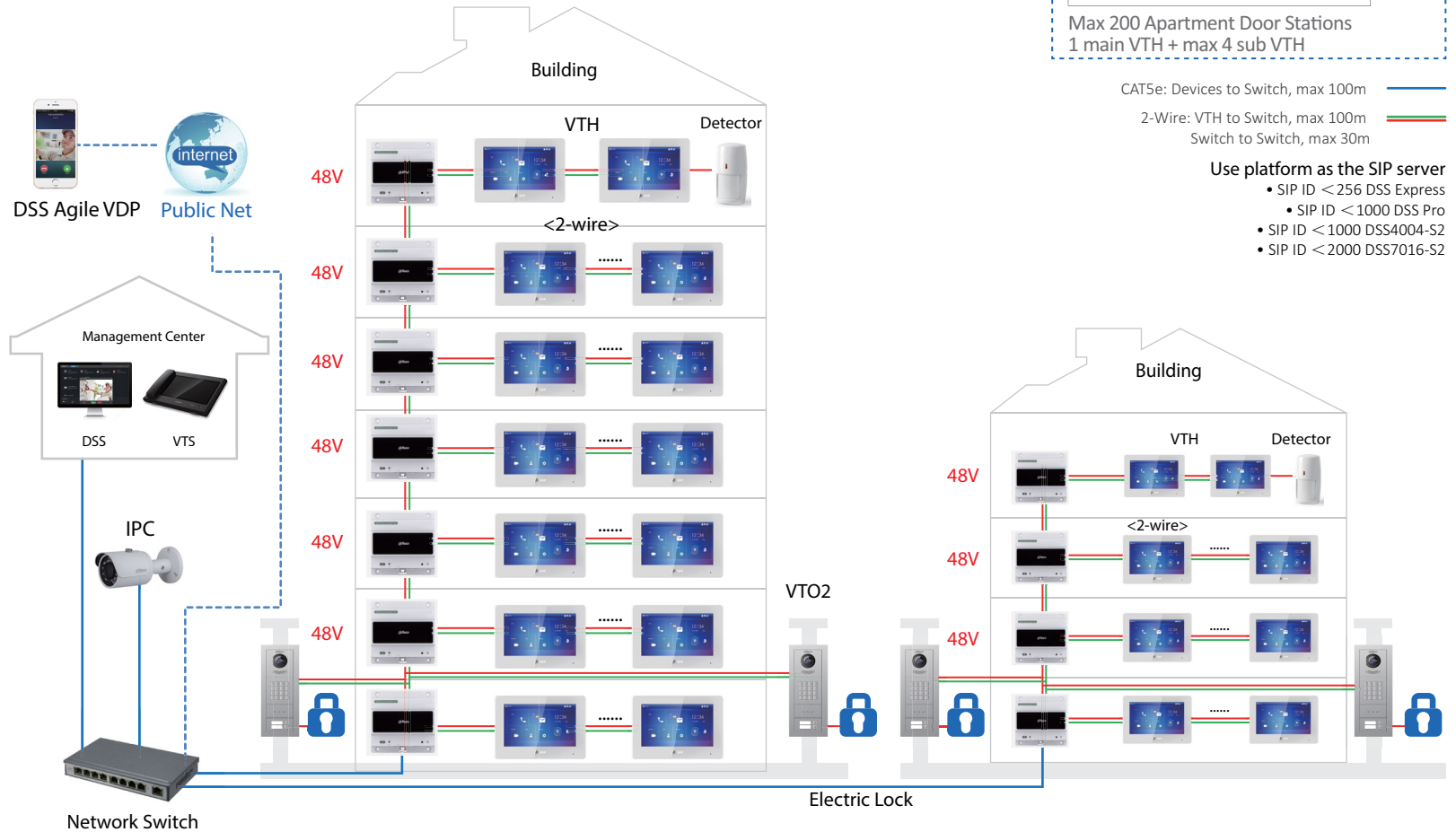

## Features



Video & Audio Calls



Night Vision



Group Calls



Emergency Calls



Remote Unlock



Alarm Integration



Video & Audio Messaging



IPC Surveillance

## Recommended Products



**VTO4202F-P-S2**  
Camera module  
2MP 160°  
IP65, IK07



**VTO4202F-MB5**  
Five-button module  
IP65, IK07



**VTO4202F-MS**  
Display module  
3.0" STN  
IP65, IK07



**VTO4202F-MF**  
Fingerprint module  
IP65, IK07



**VTH5422HW**  
Indoor Monitor  
7" Capacitive  
2.5D glass screen



# ENABLING A SAFER SOCIETY AND SMARTER LIVING

## Dahua USA

Tel: +1 (949) 679-7777  
Email: sales.usa@dahuatech.com  
Supported.usa@dahuatech.com

## Dahua Mexico

Tel: +52 55 67231936  
Email: sales.mx@dahuatech.com  
Supported.mx@dahuatech.com

## Dahua Colombia

Tel: +571 7446110  
Email: sales.co@dahuatech.com  
Supported.co@dahuatech.com

## Dahua Brazil

Tel: +55 11 32511871  
Vendas: comercial.br@dahuatech.com  
Suporte Técnico: suporte.br@dahuatech.com

## Dahua Perú

Tel: +511 500-8555  
Email: sales.pe@dahuatech.com  
Supported.pe@dahuatech.com

## Dahua Chile

Tel: +56 232705421  
Email: sales.cl@dahuatech.com  
Supported.chile@dahuatech.com

## Dahua Argentina

Email: project.ar@dahuatech.com

## Dahua Panama

Email: sales.pa@dahuatech.com  
Supported: Supported.pa@dahuatech.com

## Dahua Thailand

Tel: +66 2541 5188  
Email: info.th@dahuatech.com  
hr.th@dahuatech.com

## Dahua Singapore

Tel: +65 65380952  
Email: sales.sg@dahuatech.com

## Dahua Turkey

Email: sales.tr@dahuatech.com  
Supported.tr@dahuatech.com

## Dahua Malaysia

Tel: +60376620731  
Email: sales.my@dahuatech.com

## Dahua Indonesia

Tel: +62 811 867 7728  
Email: sales.indo@dahuatech.com

## Dahua S.Korea

Tel: +82 7081618889  
Email: sales.kr@dahuatech.com  
Supported.kr@dahuatech.com

## Dahua India

Tel: +91 1244569100  
Email: sales.india@dahuatech.com

## Dahua Russia

Tel: 8 (499) 682-60-00  
Email: info@dahuatech.com

## Dahua Kazakhstan

Tel: +7 727 3110838  
Email: sales.kz@dahuatech.com

## Dahua VISION LLC

Tel: +998 (78) 1488666  
E-mail: dh\_uzbekistan@dahuatech.com

## Dahua UK

Tel: +44(0)1628 613 500  
Email: sales.uk@dahuatech.com

## Dahua the Netherlands

Tel: +31 (0) 79 799 96 96  
Email: sales.benelux@dahuatech.com

## Dahua Iberia

Tel: +34 917649862  
Email: sales.iberia@dahuatech.com

## Dahua Italy

Tel: +39 362182681  
Email: sales.italy@dahuatech.com

## Dahua Germany

Tel: +49 211 20544121  
Email: sales.de@dahuatech.com

## Dahua France

+33 1 48 53 70 53  
Email: sales.france@dahuatech.com

## Dahua CEE & Nordic

Tel: +48 223957400  
Email: dh.cen@dahuatech.com

## Dahua Poland

Tel: +48 223957400  
Email: biuro.pl@dahuatech.com

## Dahua SRB

+38 1 (11) 4429999  
Email: dh.srb@dahuatech.com

## Dahua Denmark

Email: Nordic.ne@dahuatech.com

## Dahua Hungary

Tel: +36 17899852  
Email: sales.hu@dahuatech.com

## Dahua Bulgaria

Tel: +35929950013  
Email: Supported.bg@dahuatech.com

## Dahua SRL

Email: marketing.ro@dahuatech.com

## Dahua Czech

Tel: +420 225 986 001  
Email: admin.cz@dahuatech.com

## Dahua S. Africa

Email: sales.za@dahuatech.com

## Dahua Australia

Tel: +61 299285200  
Email: sales.oc@dahuatech.com

## Dahua Middle East

Tel: +971 48815300  
Email: sales.me@dahuatech.com  
info.me@dahuatech.com

\*Design and specifications are subject to change without notice.

Ver. H1, Mar. 2022



## Dahua Technology CEE & Nordic & Turkey

[facebook.com/DahuaCEEN](https://facebook.com/DahuaCEEN)

[linkedin.com/dahua-technology-ceed](https://linkedin.com/dahua-technology-ceed)

